

Aktor-/Sensor-Verteiler mit LED-Betriebs- und Funktions-anzeige, 4-, 6- und 8-fach, kombinierte FIXCON-/M12-Buchse, 5-polig, 2 Signale pro Buchse, Erdanschluss, fest angeschlossen Kabel

Actuator/sensor distribution box with LED operation and function indicators, 4, 6 and 8 ports, combined FIXCON/M12 socket, 5 poles, 2 signals per socket, earth connection, integrated control cable

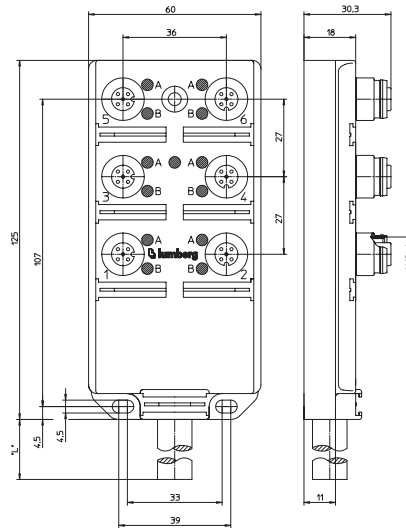
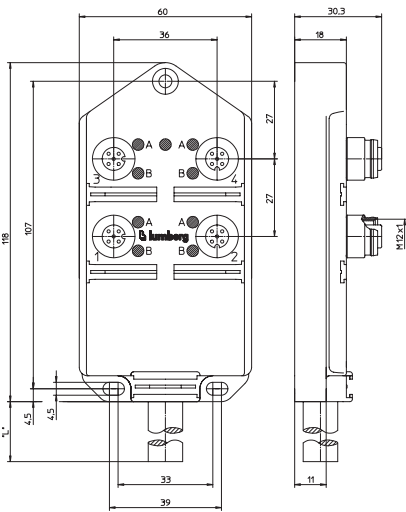
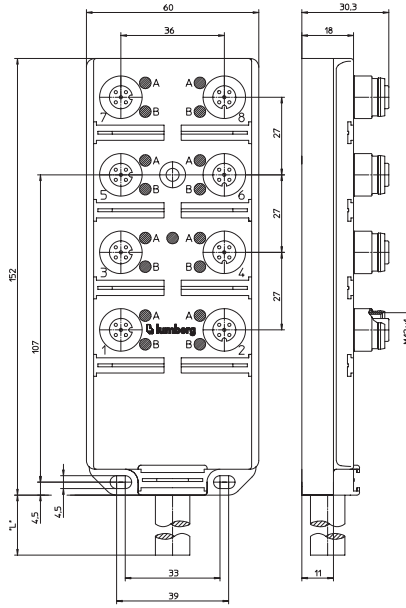

Pinbelegung / Schaltbild
Pin assignment / wiring diagram

4-fach
4 ports

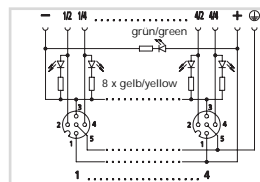

- | | |
|------------------------------|------|
| 1 = braun / brown | (+) |
| 2 = grau/rosa / grey/pink | (1) |
| rot/blau / red/blue | (2) |
| weiß/grün / white/green | (3) |
| braun/grün / brown/green | (4) |
| 3 = blau / blue | (-) |
| 4 = weiß / white | (1) |
| grün / green | (2) |
| gelb / yellow | (3) |
| grau / grey | (4) |
| 5 = grün/gelb / green/yellow | (PE) |

6-fach
6 ports

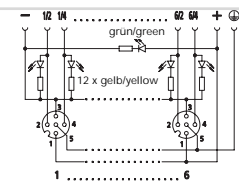

- | | |
|------------------------------|------|
| 1 = braun / brown | (+) |
| 2 = grau/rosa / grey/pink | (1) |
| rot/blau / red/blue | (2) |
| weiß/grün / white/green | (3) |
| braun/grün / brown/green | (4) |
| weiß/gelb / white/yellow | (5) |
| gelb/braun / yellow/brown | (6) |
| 3 = blau / blue | (-) |
| 4 = weiß / white | (1) |
| grün / green | (2) |
| gelb / yellow | (3) |
| grau / grey | (4) |
| rosa / pink | (5) |
| rot / red | (6) |
| 5 = grün/gelb / green/yellow | (PE) |

8-fach
8 ports

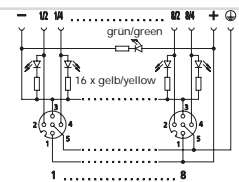













- | | |
|------------------------------|------|
| 1 = braun / brown | (+) |
| 2 = grau/rosa / grey/pink | (1) |
| rot/blau / red/blue | (2) |
| weiß/grün / white/green | (3) |
| braun/grün / brown/green | (4) |
| weiß/gelb / white/yellow | (5) |
| gelb/braun / yellow/brown | (6) |
| weiß/grau / white/grey | (7) |
| grau/braun / grey/brown | (8) |
| 3 = blau / blue | (-) |
| 4 = weiß / white | (1) |
| grün / green | (2) |
| gelb / yellow | (3) |
| grau / grey | (4) |
| rosa / pink | (5) |
| rot / red | (6) |
| schwarz / black | (7) |
| violett / violet | (8) |
| 5 = grün/gelb / green/yellow | (PE) |



| | |
|--|---|
| Technische Daten | |
| Umgebungstemperatur | -15°C / +80°C |
| Werkstoffe | |
| Gehäuse / Griffkörper | TPU, selbstverlöschend |
| Kontaktträger | PA GF, selbstverlöschend |
| Kontakt | CuZn, unternickelt und 0,8 µm vergoldet |
| Gewindebuchse / Rändelschraube/-mutter / Sechskantschraube/-mutter / Hülse | CuZn, vernickelt |
| O-Ring | FKM |
| Mechanische Daten | |
| Schutzart | IP 67 Nur im verriegelten oder verschraubten Zustand mit den dazugehörigen Gegenstücken oder Schutzkappen. |
| Elektrische Daten | |
| Durchgangswiderstand | ≤ 5 mΩ |
| Nennstrom bei 40°C | 4 A pro Steckplatz / 12 A max. gesamt |
| Nennspannung | 10–30 V DC |
| Bemessungsspannung | 32 V |
| Isolationswiderstand | > 10 ⁹ Ω |
| Verschmutzungsgrad | 3 |
| Zubehör (inkl.) | |
| ZVK | 2 Schutzkappen für nicht belegte Kupplungsgehäuse |
| ZBS | 10 Beschriftungsschilder |

| | |
|---|---|
| Technical data | |
| Operating temperature range | -15°C / +80°C |
| Materials | |
| Housing / Molded body | TPU, self-extinguishing |
| Insert | PA GF, self-extinguishing |
| Contact | CuZn, pre-nickelated and 0.8 microns gold-plated |
| Receptacle shell / knurled screw/nut / hexagon screw/nut / sleeve | CuZn, nickel-plated |
| O-ring | FKM |
| Mechanical data | |
| Degree of protection | IP 67 Only in locked position with its proper counterparts or dust covers. |
| Electrical data | |
| Contact resistance | ≤ 5 mΩ |
| Nominal current at 40°C | 4 A per outlet / 12 A max. total |
| Nominal voltage | 10–30 V DC |
| Rated voltage | 32 V |
| Insulation resistance | > 10 ⁹ Ω |
| Pollution degree | 3 |
| Accessories (incl.) | |
| ZVK | 2 dust covers for unused sockets |
| ZBS | 10 attachable labels |

| Bestellbezeichnung Designation | Ausführung Version | Mantel Outer jacket | |
|---|-----------------------|--|---|
| ASBV 4/LED 5-256/... M | 4-fach / 4 ports | PUR halogenfrei / halogen free |     |
| ASBV 6/LED 5-332/... M | 6-fach / 6 ports | PUR halogenfrei / halogen free |     |
| ASBV 8/LED 5-242/... M | 8-fach / 8 ports | PUR halogenfrei / halogen free |     |
| Standardlängen: 5 M / 10 M / 15 M | | Standard lengths: 5 M / 10 M / 15 M | |
| Andere Kabellängen oder Leitungsaufbauten auf Anfrage. | | Other cable lengths or cable specifications on request. | |

Ein Einsatz der Produkte in aggressiven Medien ist im Einzelfall zu überprüfen.

The application of these products in harsh environments should always be checked before use.